



CP 50

- 1 Eléments ouvrants (duorail)
- 2 Eléments ouvrants (3-rails)
- 3 Eléments ouvrants
- 4 Combinaisons dans le système

Combinaisons avec d'autres systèmes



1 Eléments ouvrants (duorail)

Dormants

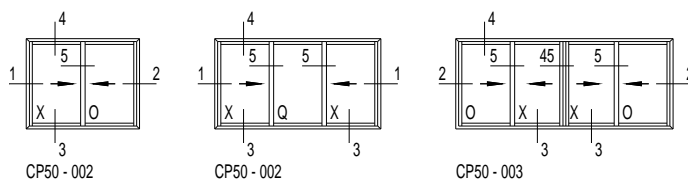

2 Eléments ouvrants (3-rails)

Dormants

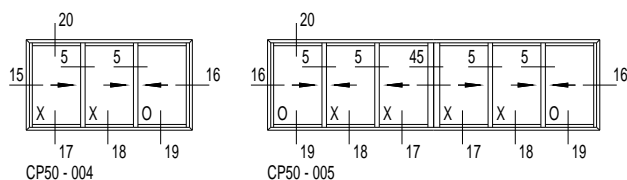

3 Eléments ouvrants

Bavettes

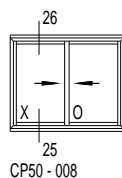

4 Combinaisons dans le système

Dormants

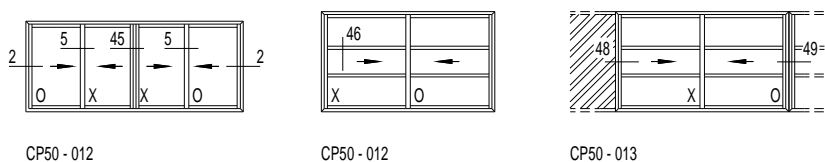



Dormants

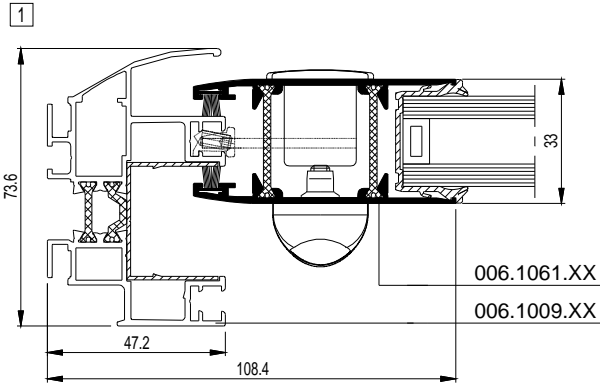
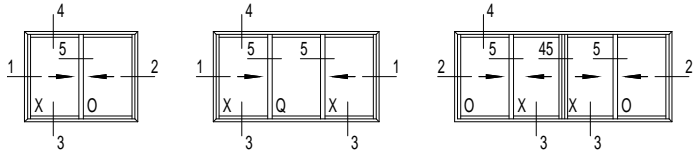

... .dxf
dwg

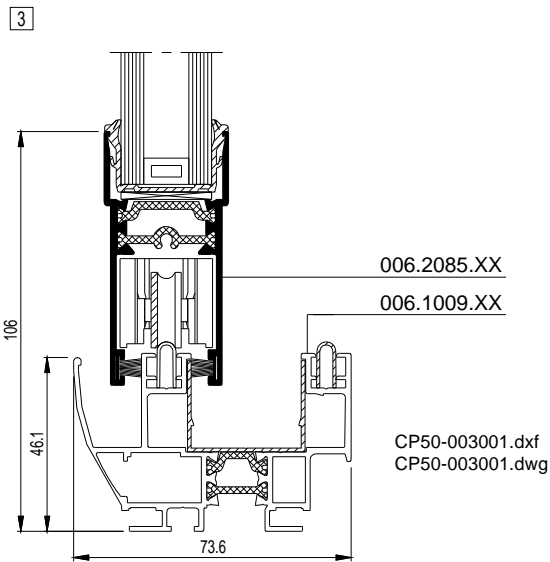
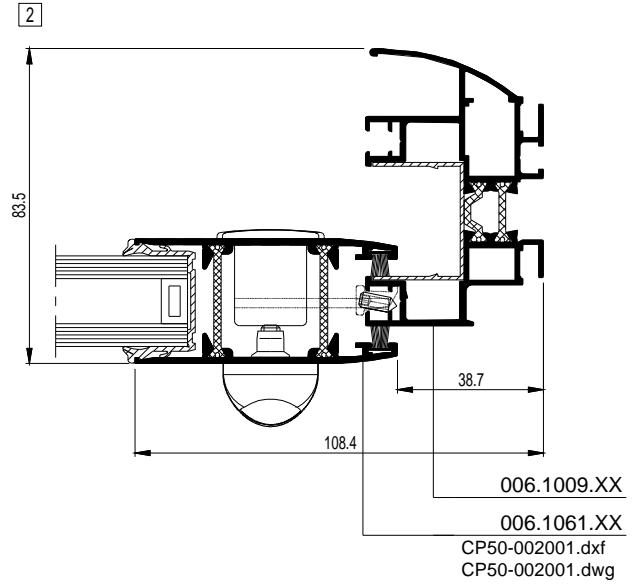

... .dxf
dwg

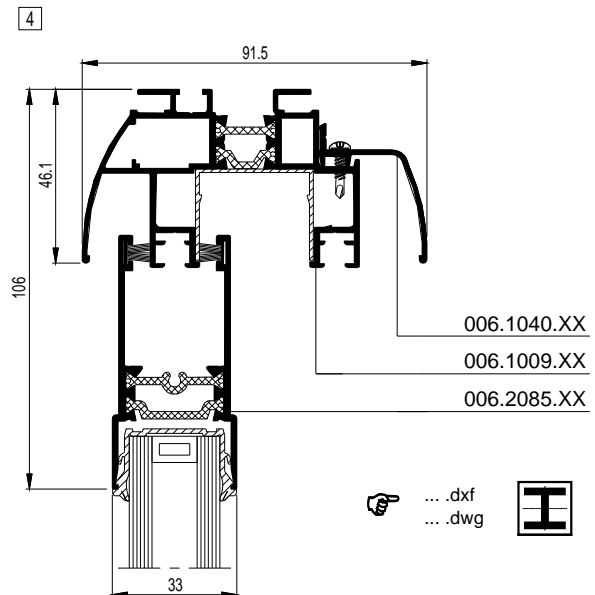



Dormants

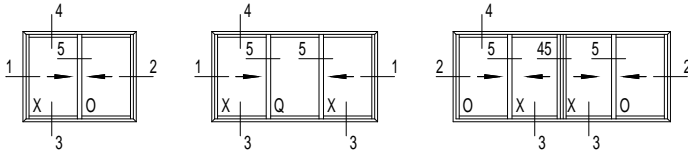

006.1009.XX

$I_x = 18.325 \text{ cm}^4$

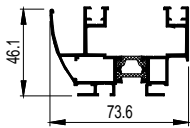

1 CP50-001001.dxf
CP50-001001.dwg

4 CP50-004001.dxf
CP50-004001.dwg

006.1001.XX

$I_x = 22.013 \text{ cm}^4$

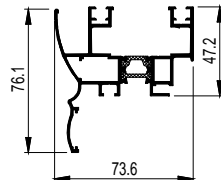

1 CP50-001002.dxf
CP50-001002.dwg

006.1007.XX

$I_x = 18.701 \text{ cm}^4$

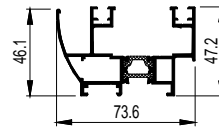

1 CP50-001003.dxf
CP50-001003.dwg

006.1015.XX

$I_x = 13.493 \text{ cm}^4$

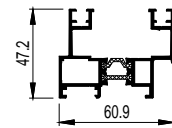

1 CP50-001004.dxf
CP50-001004.dwg

006.1016.XX

$I_x = 13.080 \text{ cm}^4$

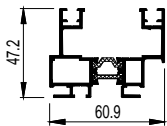

1 CP50-001005.dxf
CP50-001005.dwg

006.1061.XX

$I_x = 4.832 \text{ cm}^4$

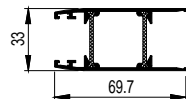

1 CP50-001006.dxf
CP50-001006.dwg

006.1062.XX

$I_x = 15.013 \text{ cm}^4$

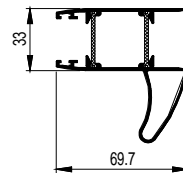

1 CP50-001007.dxf
CP50-001007.dwg

006.1063.XX

$I_x = 23.457 \text{ cm}^4$

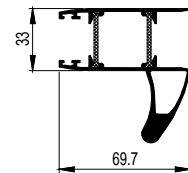

1 CP50-001008.dxf
CP50-001008.dwg

006.1068.XX

$I_x = 7.984 \text{ cm}^4$

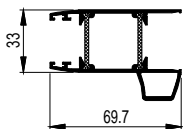

1 CP50-001009.dxf
CP50-001009.dwg



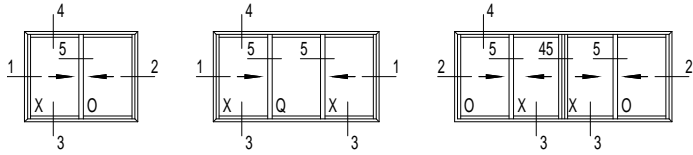

Dormants

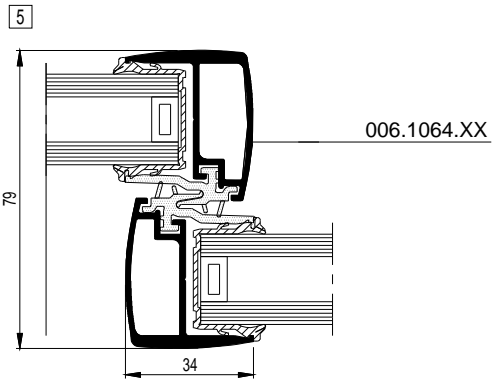

☞dxf
... .dwg



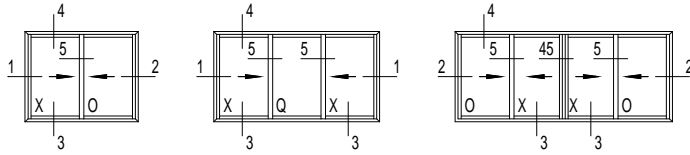

Dormants

006.1064.XX

$I_x = 4.646 \text{ cm}^4$

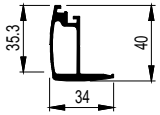

CP50-005001.dxf
CP50-005001.dwg

006.1065.XX

$I_x = 14.854 \text{ cm}^4$

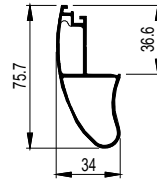

CP50-005002.dxf
CP50-005002.dwg

006.1067.XX

$I_x = 7.444 \text{ cm}^4$

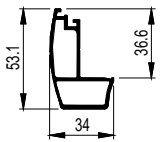

CP50-005003.dxf
CP50-005003.dwg

006.1066.XX

$I_x = 23.568 \text{ cm}^4$

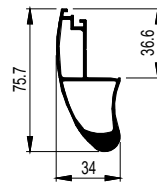

CP50-005004.dxf
CP50-005004.dwg





Dormants

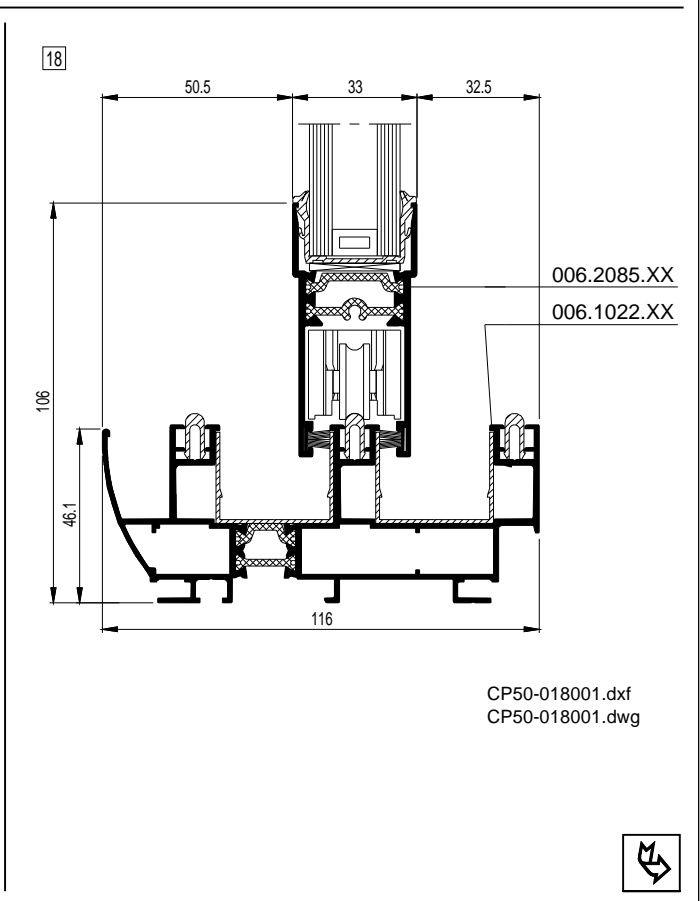
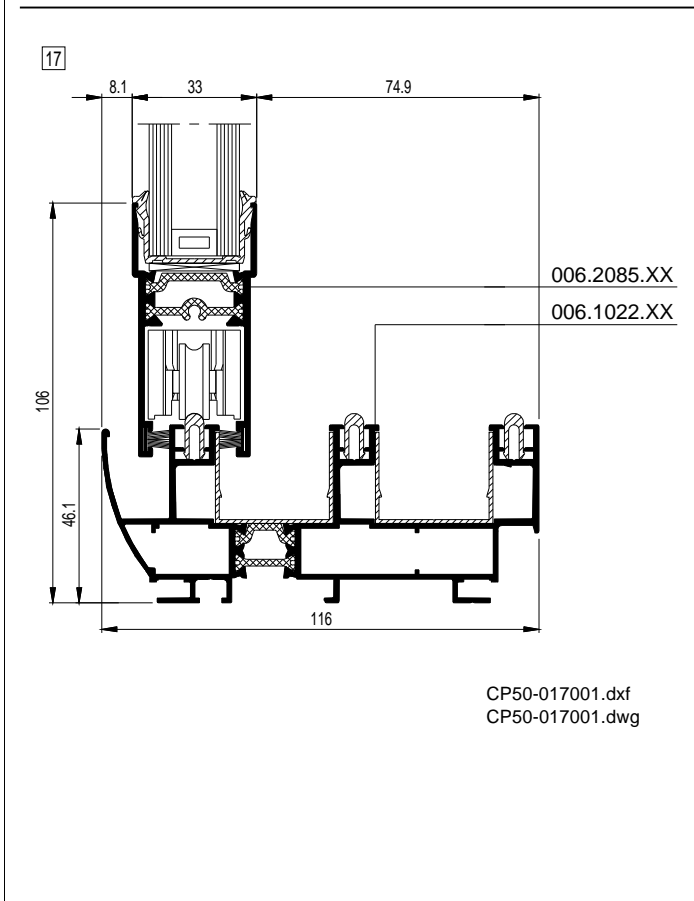
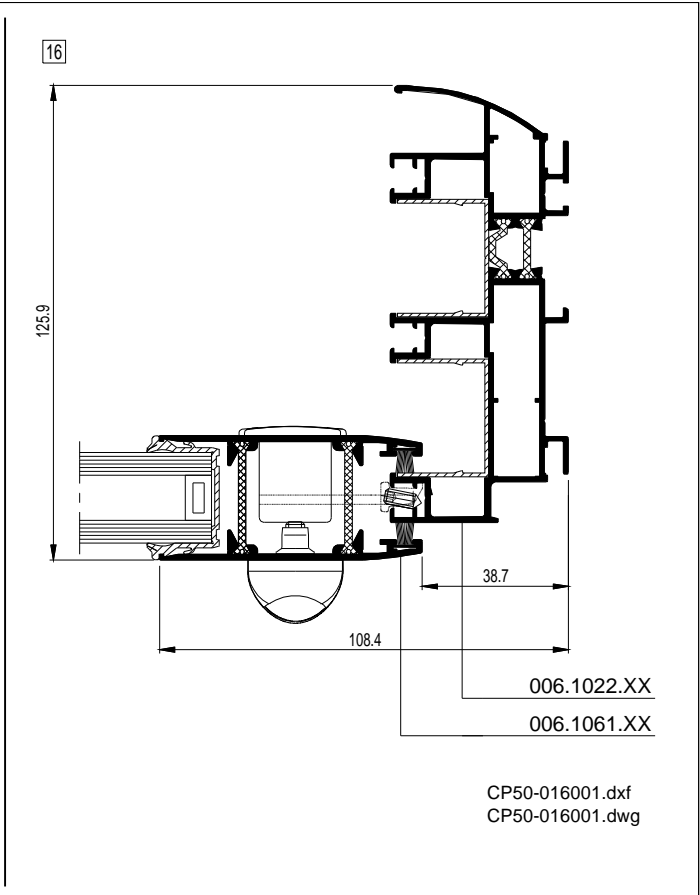
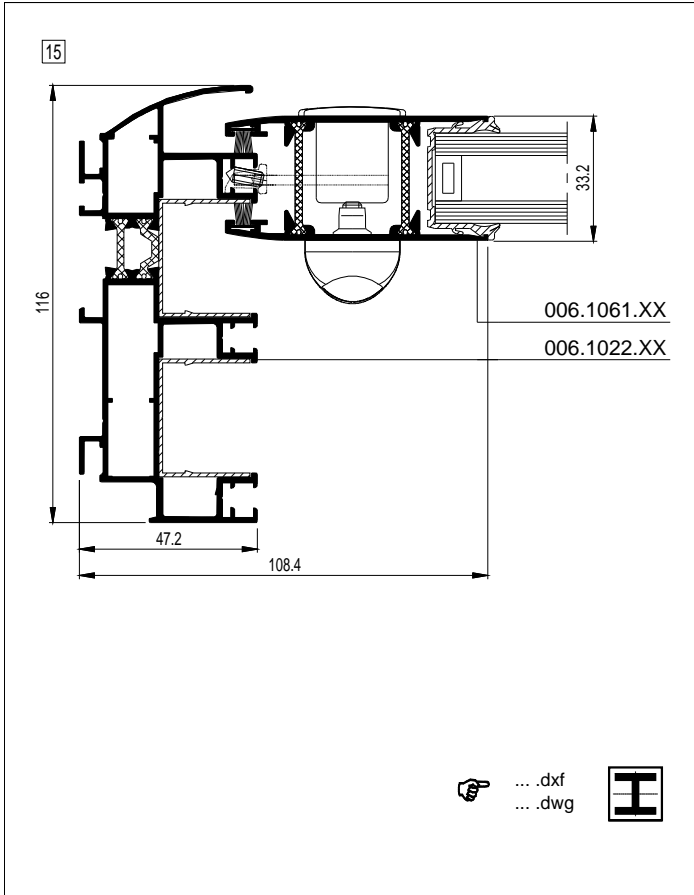
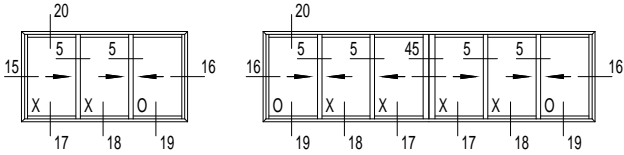



Dormants

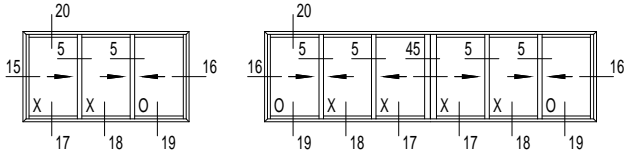

006.1021.XX

$I_x = 65.562 \text{ cm}^4$

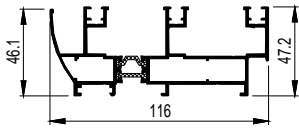

15 CP50-015001.dxf
CP50-015001.dwg

20 CP50-020001.dxf
CP50-020001.dwg

006.1022.XX

$I_x = 62.298 \text{ cm}^4$

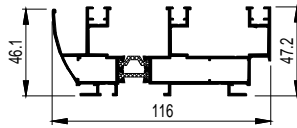

15 CP50-015002.dxf
CP50-015002.dwg

20 CP50-020002.dxf
CP50-020002.dwg

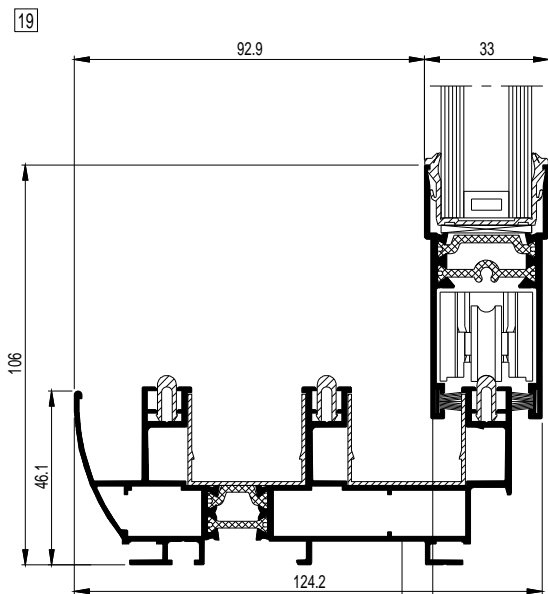

006.2085.XX

006.1022.XX

CP50-019001.dxf
CP50-019001.dwg

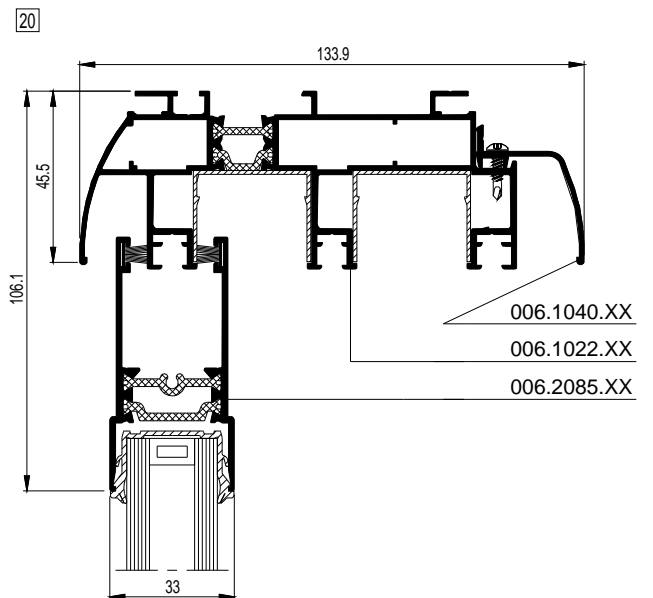

006.1040.XX

006.1022.XX

006.2085.XX

☞ ...dxf
☞ ...dwg





Bavettes

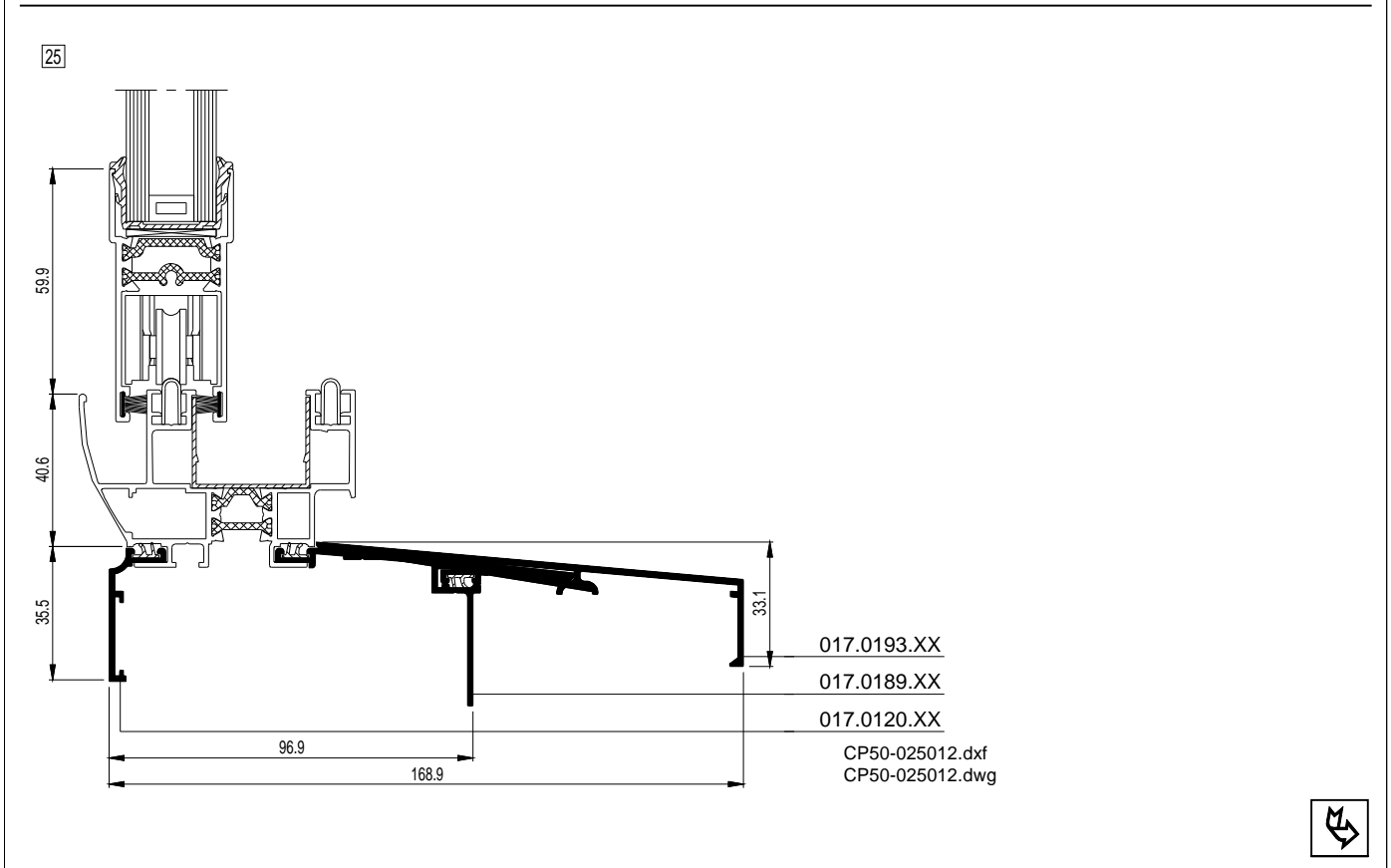
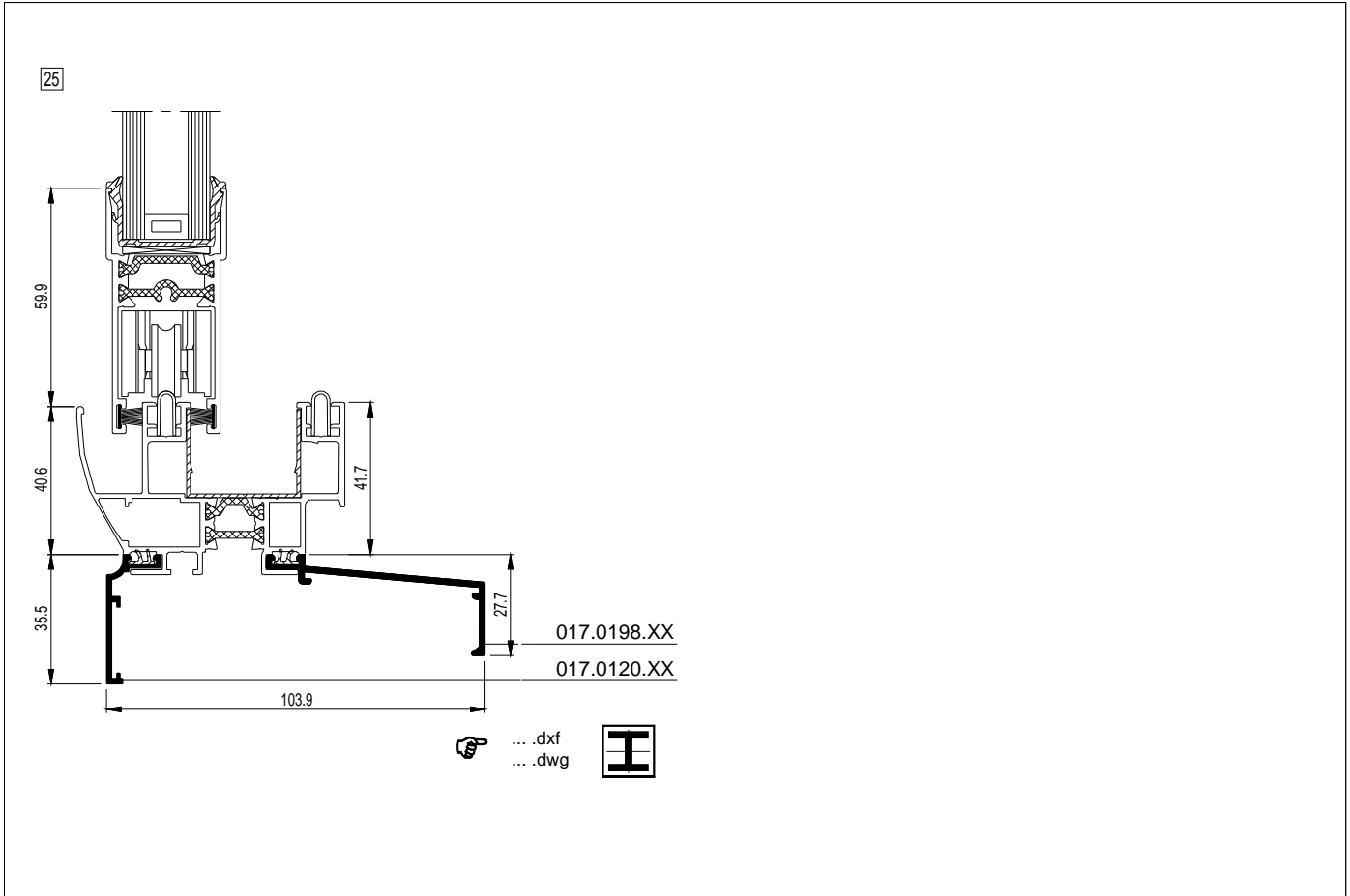
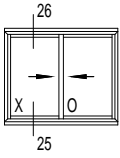



Bavettes

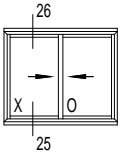

017.0197.XX

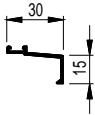

[25] CP50-025001.dxf
CP50-025001.dwg

017.0198.XX

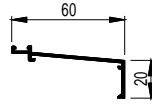

[25] CP50-025002.dxf
CP50-025002.dwg

017.0199.XX

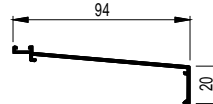

[25] CP50-025003.dxf
CP50-025003.dwg

017.0131.XX

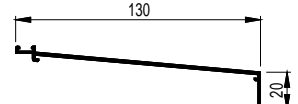

[25] CP50-025004.dxf
CP50-025004.dwg

017.0234.XX

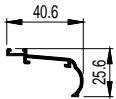

[25] CP50-025006.dxf
CP50-025006.dwg

017.0233.XX

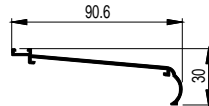

[25] CP50-025007.dxf
CP50-025007.dwg

017.0235.XX

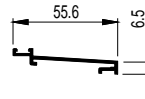

[25] CP50-025008.dxf
CP50-025008.dwg

017.0277.XX

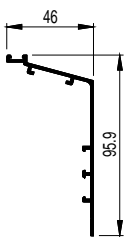

[25] CP50-025009.dxf
CP50-025009.dwg

017.5003.XX

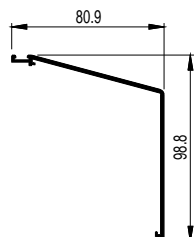

[25] CP50-025010.dxf
CP50-025010.dwg

017.0129.XX

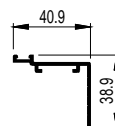

[25] CP50-025011.dxf
CP50-025011.dwg

017.0193.XX

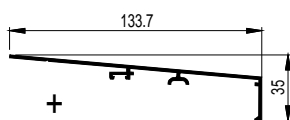

+
017.0189.XX

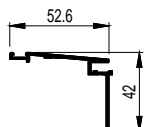

[25] CP50-025012.dxf
CP50-025012.dwg

017.0193.XX

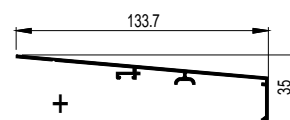

+
017.0190.XX

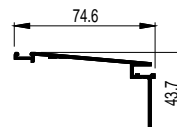

[25] CP50-025013.dxf
CP50-025013.dwg



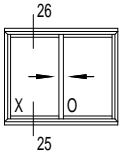

Bavettes

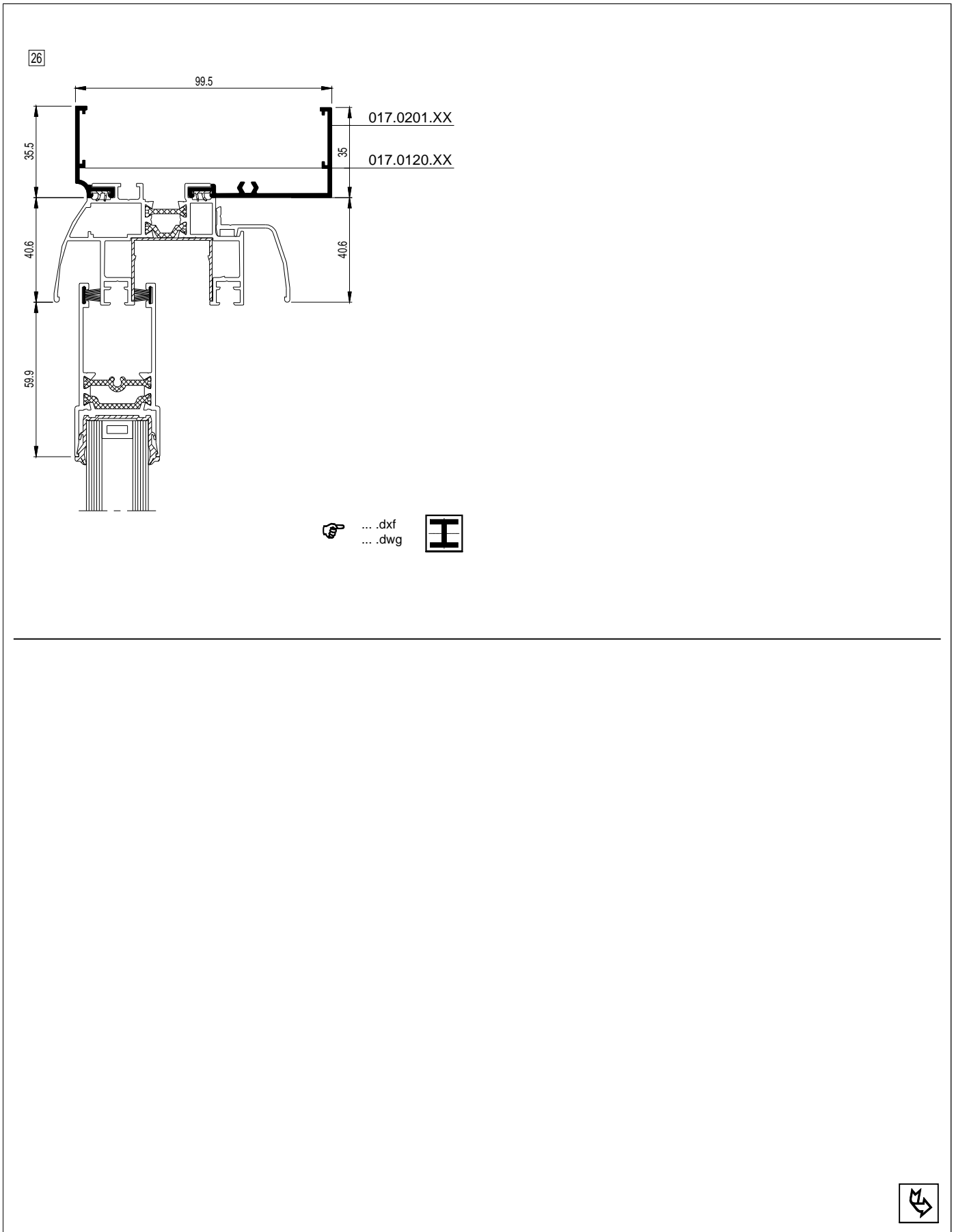



Bavettes

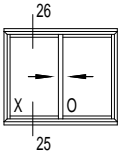

<p>017.0077.XX</p> <p>[26] CP50-026001.dxf CP50-026001.dwg</p>	<p>017.0110.XX</p> <p>[26] CP50-026002.dxf CP50-026002.dwg</p>	<p>017.0119.XX</p> <p>[26] CP50-026003.dxf CP50-026003.dwg</p>	<p>017.0120.XX</p> <p>[26] CP50-026004.dxf CP50-026004.dwg</p>	<p>017.0131.XX</p> <p>[26] CP50-026005.dxf CP50-026005.dwg</p>
<p>017.0201.XX</p> <p>[26] CP50-026001.dxf CP50-026001.dwg</p>	<p>017.0202.XX</p> <p>[26] CP50-026006.dxf CP50-026006.dwg</p>	<p>017.0203.XX</p> <p>[26] CP50-026007.dxf CP50-026007.dwg</p>	<p>017.0204.XX</p> <p>[26] CP50-026008.dxf CP50-026008.dwg</p>	
<p>017.0216.XX</p> <p>[26] CP50-026009.dxf CP50-026009.dwg</p>	<p>017.0211.XX</p> <p>[26] CP50-026010.dxf CP50-026010.dwg</p>	<p>017.0212.XX</p> <p>[26] CP50-026011.dxf CP50-026011.dwg</p>	<p>017.0213.XX</p> <p>[26] CP50-026012.dxf CP50-026012.dwg</p>	
<p>017.0214.XX</p> <p>[26] CP50-026013.dxf CP50-026013.dwg</p>				



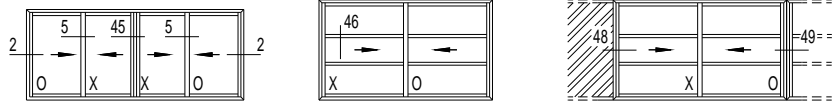

Dormants

45

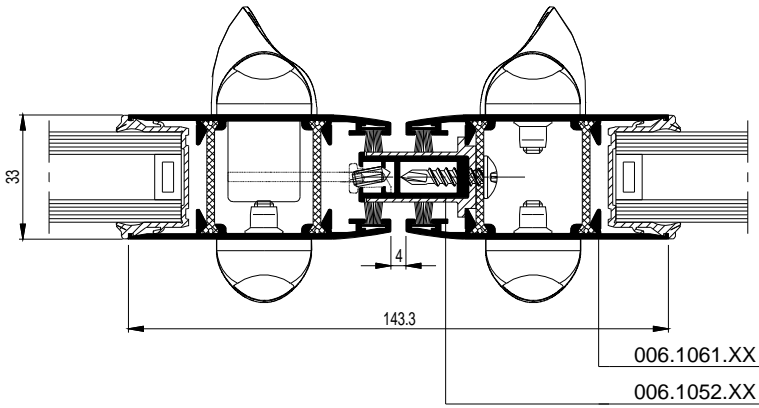

CP50-045001.dxf
CP50-045001.dwg

46

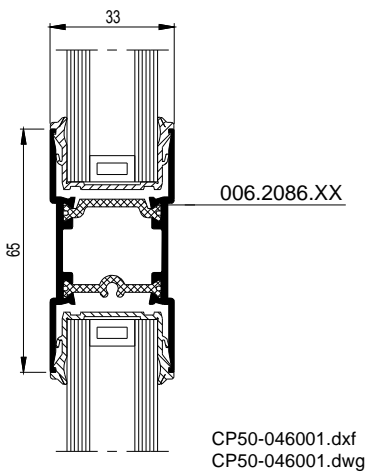

CP50-046001.dxf
CP50-046001.dwg

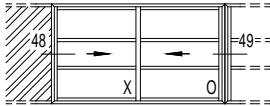

Dormants

48

017.0120.XX

006.1009.XX

50

CP50-048001.dxf
CP50-048001.dwg

49

017.0210.XX

006.1009.XX

CP50-049001.dxf
CP50-049001.dwg

49

006.1007.XX

030.0138.XX

CP50-049002.dxf
CP50-049002.dwg



Combinaisons avec d'autres systèmes

CS 59
CS 77
CW 50
CR 120

CP 50 - CN002
CP 50 - CN002
CP 50 - CN003
CP 50 - CN004



CS 59 - CS 77

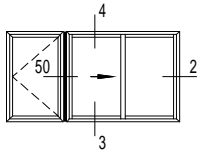

CS 59

50

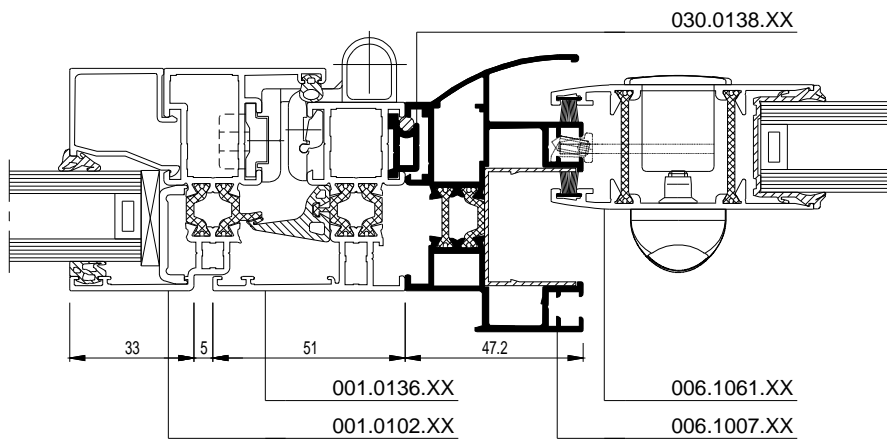

CP50-050001.dxf
CP50-050001.dwg

CS 77

50

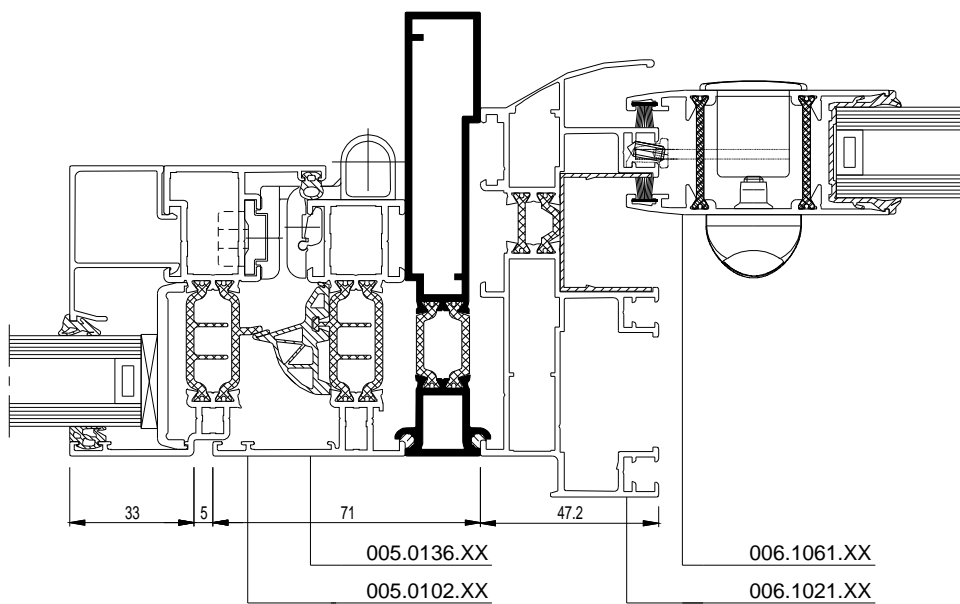

CP50-050002.dxf
CP50-050002.dwg



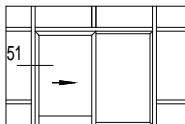

CW 50

CW 50

51

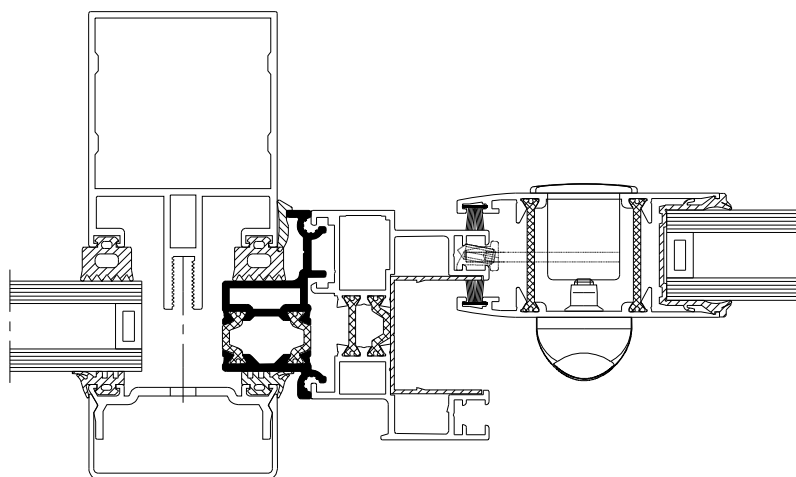

CP50-051001.dxf
CP50-051001.dwg

CW 50

51

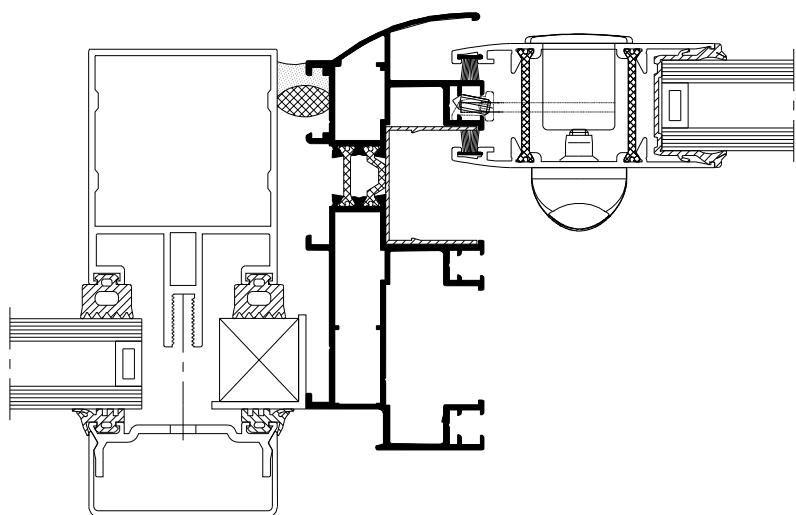

CP50-051002.dxf
CP50-051002.dwg



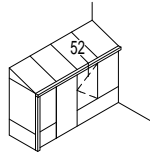

CR 120

52

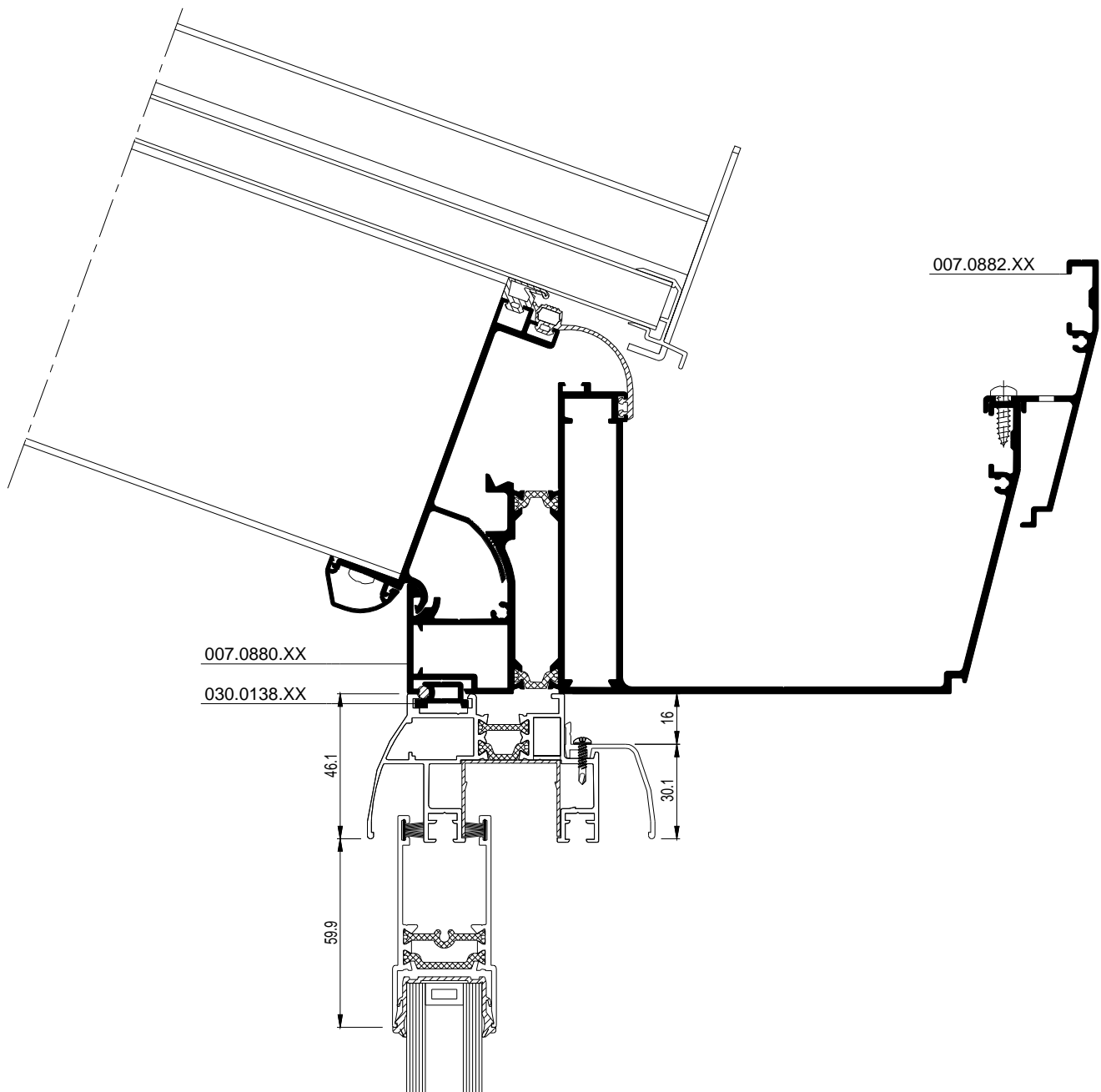

CP50-052001.dxf
CP50-052001.dwg

